

Point G2 – Small (BGS409 S)

Point G2 is a surface mounted, exterior-rated and compact sized architectural LED direct view dot lighting luminaire that is designed for façade and outdoor lighting applications.

The robust mechanical and unique optical covers make Point G2 ideal for building facades, bridges, theaters, amusement parks and recreational centers.

Available in white, monochromatic colors, RGB, RGBW and tunable white.

Three optical covers options and DMX control interface available to give architects and designers the freedom to explore a wide range of concepts and design with no limitations.



Key Features (BGS409 S)

- Low power LEDs to deliver smooth and soft direct view light
- Standard: RGBW, RGB, 3000K, 4000K and tW
- Optional 2700K, 5000K, 6500K, Monochromatic Colors
- Clear flat, opal and diamond spherical optical covers options
- Robust Design & IP66 rating for outdoor use
- Through wiring for power and DMX data via IP67 connectors
- Available in DMX512 control interface option

Ordering guide

ex: BGS409 S 12LED 40K 24V CFC DMX 3W

BGS409 S		12LED	24V			
Family	# of LEDs	CCT / Color	Voltage	Cover Type	Control ⁽¹⁾	Power
BGS409 S – Point G2	12LED	27K – 2700K 30K – 3000K 40K – 4000K 50K – 5000K RGB – RGB tW – Tunable White RGBWW – RGBW(3000K) RGBNW – RGBW(4000K) BL – Blue RD – Red GN – Green AM – Amber	24V – 24V DC	CFC – Clear Flat Cover OSC – Opal Spherical Cover DSC – Diamond Spherical Cover	– On/Off DMX – DMX	

(1) RGB, RGBW and tW are only available in DMX control interface

Product Data

Product Family	Point G2 Small (BGS409 S)
Dimensions (W x H x D)	78.5mm x 23.8mm x 62.3mm (CFC) 78.5mm x 44.5mm x 62.3mm (DSC) 78.5mm x 44.1mm x 62.3mm (OSC)
Standard Optical Covers	Clear flat Opal spherical Diamond spherical
Source	Low power LED
Lumen Maintenance	50,000 hrs L70B50 at 35°C
Housing	Die-cast aluminum
Finishing	Electrostatically applied polyester powder coating
Color	Dark Grey (RAL7012)
Cover	Anti-aging and anti-UV PC Cover
Gasket	Silicon
Max Weight	0.13 kg
Control Interfaces	On/Off DMX512
Input Voltage	24V DC
Maximum Current	6A
IEC Classification	Class III
Power Cable (On/Off)	2 pole flat cable L=30cm, 2x1.0mm ² with connectors
Power/Signal Cable (DMX)	5 pole flat cable L=30cm, 2x1.0mm ² + 3x0.3mm ² with connectors
Connectors	IP67 male/female connectors for through wiring
Number of LEDs	12LED
Standard CCT/Color	3000K, 4000K, RGB, RGBW, tW
Max Power Consumption	3W
Beam Angle/Cover	CFC OSC DSC
Standard CRI	80
White SDCM	4
Colors Wavelengths	R: 620 to 625nm; G: 525 to 530nm; B: 470 to 475nm
Temperature Range	-40°C to 50°C (Operating) -35°C to 50°C (Startup) -40°C to 70°C (Storage)
Protection Rating	IP66, IK06
Certification	CE, CB
Warranty	3 Years

Luminaire Dimensions:

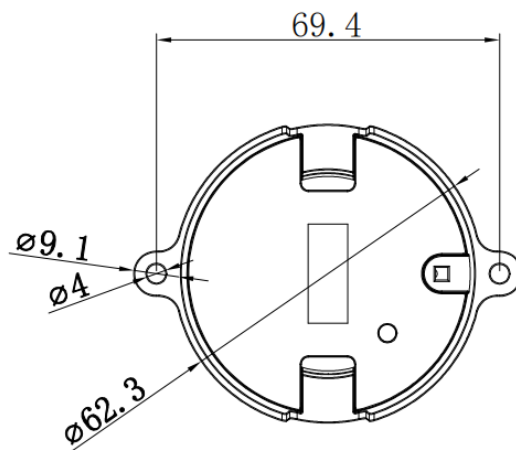

CFC

DSC

OSC

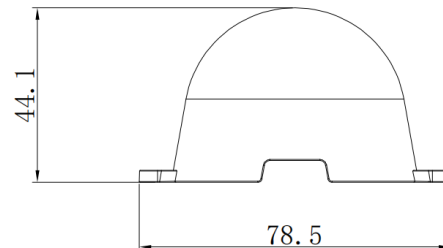
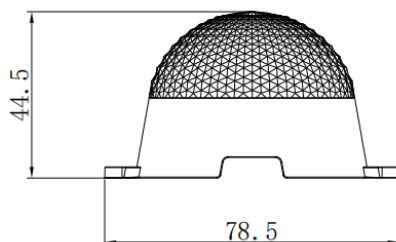
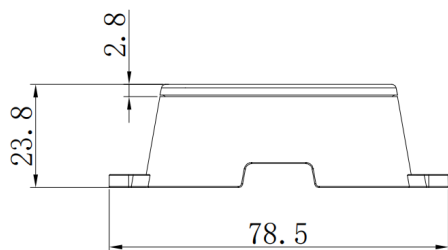

Rev. 202406

CFC – Clear Flat Cover

Features:

The clear flat cover offers a higher luminance, sharper viewing angle and a more compact size.



OSC – Opal Spherical Cover

Features:

Use the spherical opal cover for a diffused and smooth lighting effect with a wider viewing angle



DSC – Diamond Spherical Cover

Features:

Use the diamond spherical cover for a more aesthetic look by day and unique light effect by night.



Order Information:

Description
BGS409 S 12LED 30K 24V CFC 3W
BGS409 S 12LED 40K 24V CFC 3W
BGS409 S 12LED 30K 24V OSC 3W
BGS409 S 12LED 40K 24V OSC 3W
BGS409 S 12LED 30K 24V DSC 3W
BGS409 S 12LED 40K 24V DSC 3W
BGS409 S 12LED 30K 24V CFC DMX 3W
BGS409 S 12LED 40K 24V CFC DMX 3W
BGS409 S 12LED 30K 24V OSC DMX 3W
BGS409 S 12LED 40K 24V OSC DMX 3W
BGS409 S 12LED 30K 24V DSC DMX 3W
BGS409 S 12LED 40K 24V DSC DMX 3W
BGS409 S 12LED tW 24V CFC DMX 3W
BGS409 S 12LED tW 24V OSC DMX 3W
BGS409 S 12LED tW 24V DSC DMX 3W
BGS409 S 12LED RGB 24V CFC DMX 3W
BGS409 S 12LED RGB 24V OSC DMX 3W
BGS409 S 12LED RGB 24V DSC DMX 3W
BGS409 S 12LED RGB40K 24V CFC DMX 3W
BGS409 S 12LED RGB40K 24V OSC DMX 3W
BGS409 S 12LED RGB40K 24V DSC DMX 3W
BGS409 S 12LED RGB30K 24V CFC DMX 3W
BGS409 S 12LED RGB30K 24V OSC DMX 3W
BGS409 S 12LED RGB30K 24V DSC DMX 3W

¹Other options are available upon request

Accessories:

Description
ZXP390 Lead 2P DC cable 2m (10 pcs)
ZXP390 Jump 2P DC cable 2m (10 pcs)
ZXP390 Lead 5P DC/DMX cable 2m (10 pcs)
ZXP390 Jump 5P DC/DMX cable 2m (10 pcs)
ZXP390 Y-connect kit 5P DC/DMX (10 pcs)
ZXP390 Jump 5P DMX connector (10 pcs)
ZXP390 endcap male connector (20 pcs)
ZXP390 endcap female connector (20 pcs)

¹ Different cables lengths are available upon request

² End caps must be used at the end of each run

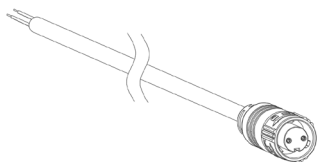

Leader cable 2P DC 2m

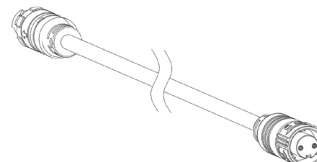

Jumper cable 2P DC 2m

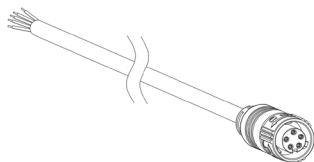

Leader cable 5P DC/DMX 2m

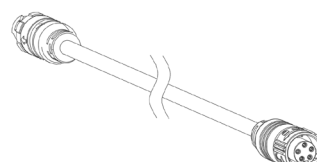

Jumper cable 5P DC/DMX 2m

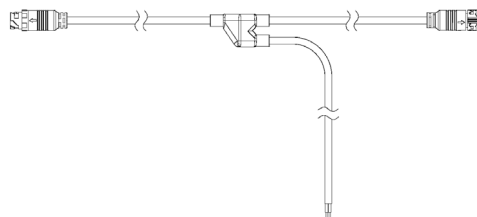

Y-connector kit 5P DC/DMX

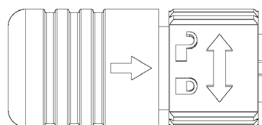

Endcap for male connectors

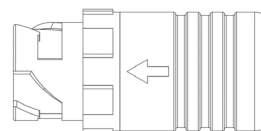

Endcap for female connectors

Rated System Lumen Output ($\pm 10\%$):

CCT/Color (All channels On)	CFC	OSC	DSC
	DMX	DMX	DMX
3000K			
4000K	175	150	230
tW	165	140	215
RGB	60	50	80
RGBNW	90	80	120
RGBWW			

