

Giant ECO G2 Triple Heads (BVP359 T)

Giant ECO G2 is a modular, rectangular shaped, cost effective and exterior-rated architectural LED floodlight that is designed for façade, landscape and outdoor flood lighting applications.

The robust mechanical design and high-efficient optical design make it ideal for illuminating multi-story exterior facades, bridges, landmarks and monuments.

Available in white, monochromatic colors, RGB, RGBW and tunable white.

Eight different spread lenses ranging from narrow spot, to wide flood and DMX512/RDM control option available to give architects and designers the freedom to explore a wide range of concepts and design with no limitations.



Key Features (BVP359 T)

- Standard: RGBW, RGB, 2700K, 3000K and 4000K
- Optional 5000K, Monochromatic Colors and Tunable White
- Standard lengths 486 and 569mm
- Wide Range of Beam Angles from Narrow Spot to Wide Flood
- 1 foot-candle at up to 440m (L57, 4000K, 3° lens)
- Robust Design & IP66 rating for outdoor use
- True Modularity: each head can be adjusted separately and the whole luminaire can be ±45° tilted
- Each head can be controlled separately (optional)
- Available in DMX512/RDM control interface option

Ordering guide

ex: *BVP359 T 216LED 40K 220V L57 10 DMX*

BVP359 T	216LED	40K	220V	L57	10	DMX
Family	# of LEDs	CCT / Color	Voltage	Length	Beam Angles	Control Interface
BVP359 T – Giant ECO G2 Triple Heads	108LED (1)	27K – 2700K 30K – 3000K 40K – 4000K 50K – 5000K BL – Blue RD – Red GN – Green AM – Amber RGB – RGB RGBA – RGBA RGBWW – RGBW(3000K) RGBNW – RGBW(4000K) tW – Tunable White	220V – 220V- 240V AC	L57 – 569mm	3 – 3°	– On/Off DMX – DMX/RDM
	216LED				10 – 10° 15 – 15° 30 – 30° 45 – 45° 60 – 60°	

(1) 108LED is available for narrow beam 3°

Product Data

Product Family	Giant ECO G2 Triple Heads (BVP359 T)	
Dimensions (L x W x H)	569mm x 478mm x 231mm (with bracket)	
Source	High power LED	
Lumen Maintenance	50,000 hrsL70B50 at 35°C for White 50,000 hrsL50B50 at 35°C for RGB	
Housing	Extruded aluminum with die-cast aluminum end caps	
Finishing	Electrostatically applied polyester powder coating	
Color	Dark Grey (RAL7012)	
Bracket	Cold rolled sheet	
Adjustability	Tilting angle $\pm 45^\circ$	
Lenses	Anti-aging and anti-UV high optical efficiency PMMA lenses	
Gasket	Silicon	
Cover	Clear tempered glass	
Control Interfaces	On/Off	DMX12/RDM
Input Voltage	220-240 VAC, 50/60Hz	
Total Harmonic Distortion	< 20%	
IEC Classification	Class I	
Power Cable (On/Off)	3 pole round cable L=50cm, 3x1.0mm ² with flying wires	
Signal Cable (DMX)	4 pole round cable L=50cm, 4x0.50mm ² (DMX versions only)	
Cables Connectors	IP67 Male/Female connectors for DMX through wiring (DMX versions only)	
Max Weight	21kg	
Standard Number of LEDs	108LED	216LED
Standard Optics	3°	10°, 15°, 30°, 45°, 60°
Max Power Consumption	300W	450W
Inrush Current ⁽¹⁾	<60A	
Maximum Number of Luminaires on 16A Type C MCB ⁽¹⁾	10	7
Standard CCT/Colors	2700K, 3000K, 4000K, RGB, RGBW	
Standard CRI	80	
White SDCM	4	
Colors Wavelength	R: 620 to 625nm; G: 525 to 530nm; B: 470 to 475nm	
Temperature Range	-40°C to 50°C (Operating) -35°C to 50°C (Startup) -40°C to 70°C (Storage)	
Protection Rating	IP66, IK06	
Certifications	CE, CB, CQC(in progressing)	
Warranty	3 Years	

(1) Inrush current and MCBs data are based on White, RGB and RGBW luminaires

Luminaire Dimensions:

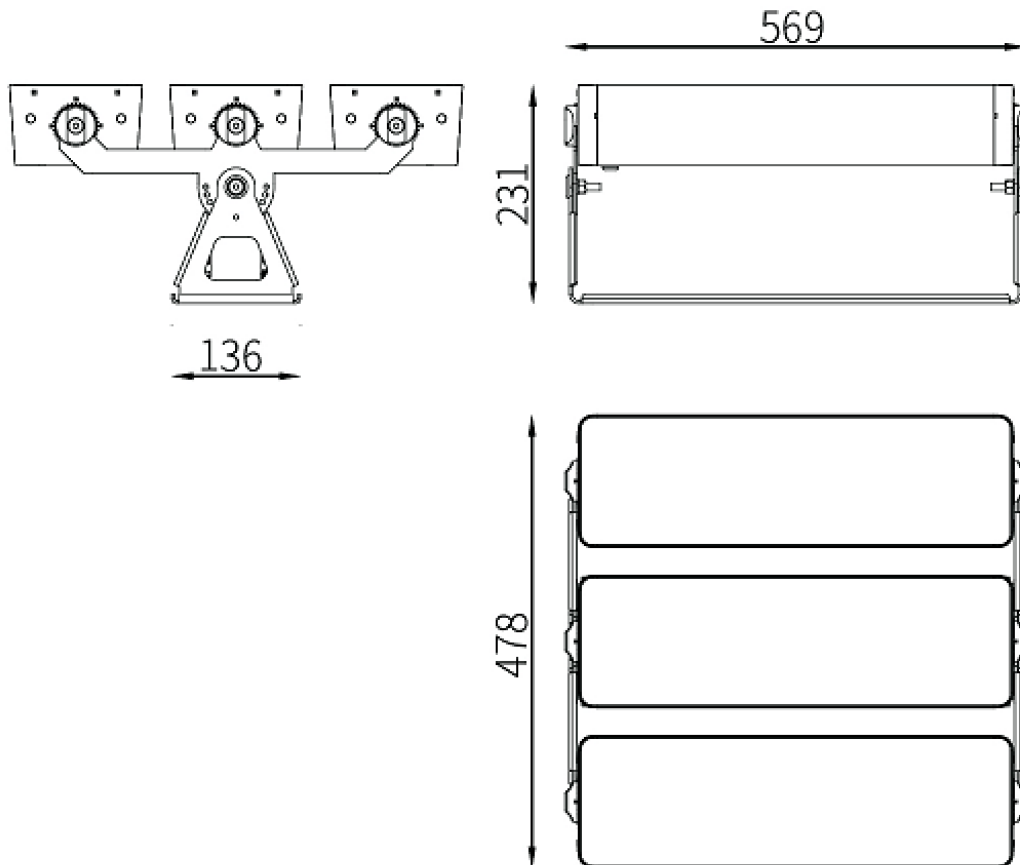

Polar Candela Distribution Curves:

3x3° Beam Angle

Features:

The 3x3° beam angle delivers a very narrow beam with more lumens where you want them.

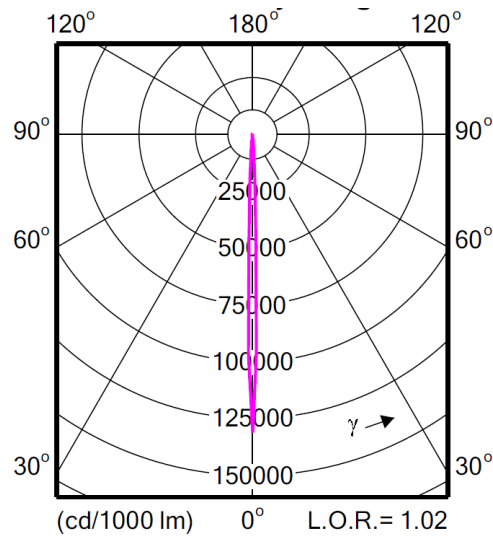

10x10° Beam Angle

Features:

The 10x10° beam angle offers a narrow beam that can be used to highlight a small area in a building or making an ornament stands out.

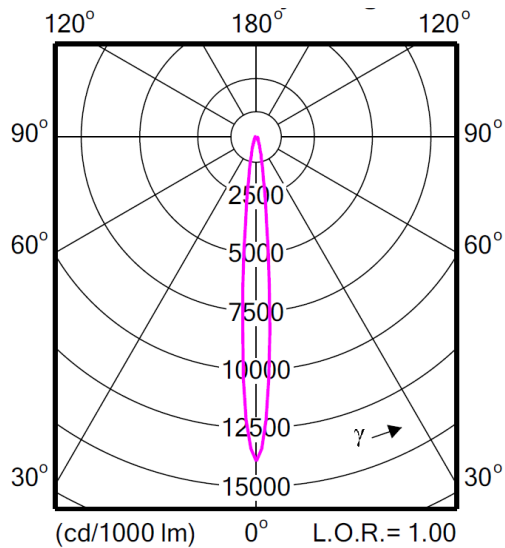

15x15° Beam Angle

Features:

The 15x15° beam angle offers a medium beam distribution that can be used to highlight a small to medium area in a building or making an ornament stands out.

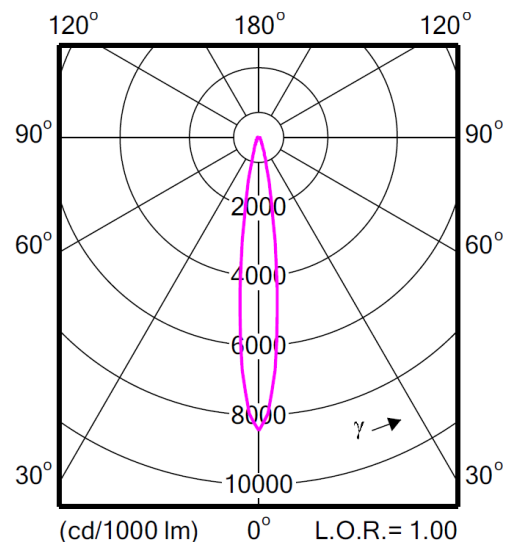

Polar Candela Distribution Curves:

30x30° Beam Angle

Features:

The 30x30° beam angle offers a wide beam that can be used for highlighting medium to large areas in a building or used for general façade lighting.

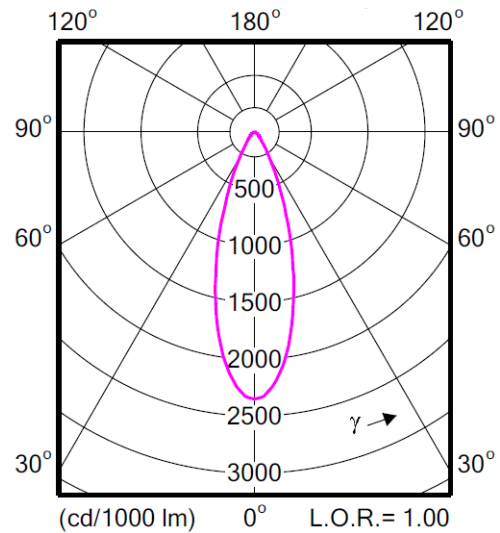

45x45° Beam Angle

Features:

The 45x45° beam angle offers a wide beam that can be used for highlighting large and wide areas in a building or used for general façade lighting.

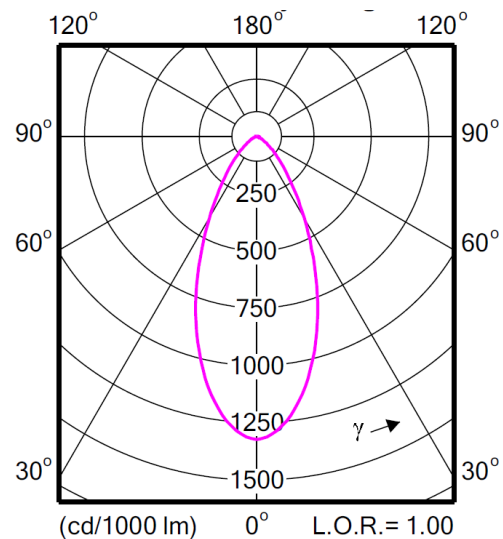

60x60° Beam Angle

Features:

The 60x60° beam angle offers a wide flood distribution that can be used to highlight larger and wider areas in a building or for general façade lighting.

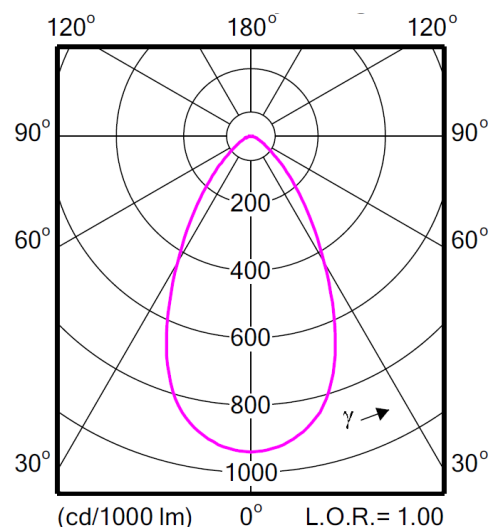

Rated System Lumen Output ($\pm 10\%$):

BVP359 T L57 Version

CCT/Color (All channels On)	3° DMX	10° DMX	15° DMX	30° DMX	45° DMX	60° DMX
2700K	13530	32535	34160	35380	34160	33345
3000K	15225	33935	35635	36905	35635	34785
4000K	15225	37860	39755	41175	39755	38810
RGB	7010	20115	21120	21875	21120	20620
RGBWW	8850	21590	22670	23480	22670	22130
RGBNW	9270	22550	23675	24520	23675	23110

Accessories

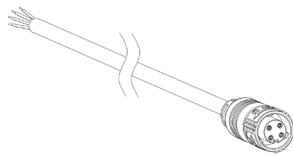

Leader cable 4P DMX
2m

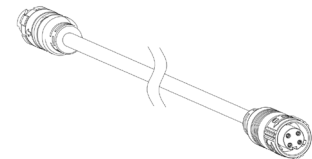

Jumper cable 4P DMX
2m

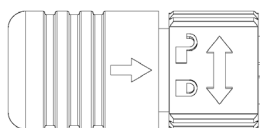

End cap for male
connectors

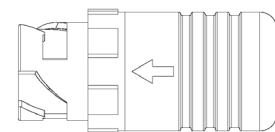

End cap for female
connectors

