

# Giant ECO G2 Triple Heads (BVP359 T)

Giant ECO G2 is a modular, rectangular shaped, cost effective and exterior-rated architectural LED floodlight that is designed for façade, landscape and outdoor flood lighting applications.

The robust mechanical design and high-efficient optical design make it ideal for illuminating multi-story exterior facades, bridges, landmarks and monuments.

Available in white, monochromatic colors, RGB, RGBW and tunable white.

Eight different spread lenses ranging from narrow spot, to wide flood and DMX512/RDM control option available to give architects and designers the freedom to explore a wide range of concepts and design with no limitations.



## Key Features (BVP359 T)

- Standard: RGBW, RGB, 2700K, 3000K and 4000K
- Optional 5000K, Monochromatic Colors and Tunable White
- Standard lengths 486 and 569mm
- Wide Range of Beam Angles from Narrow Spot to Wide Flood
- 1 foot-candle at up to 440m (L57, 4000K, 3° lens)
- Robust Design & IP66 rating for outdoor use
- True Modularity: each head can be adjusted separately and the whole luminaire can be ±45° tilted
- Each head can be controlled separately (optional)
- Available in DMX512/RDM control interface option

## Ordering guide

ex: BVP359 T 180LED 40K 220V L50 10 DMX

BVP359 T	180LED	40K	220V	L50	10	DMX
Family	# of LEDs	CCT / Color	Voltage	Length	Beam Angles	Control Interface
BVP359 T – Giant ECO G2 Triple Heads	90LED (1) 96LED <hr/> 180LED	27K – 2700K 30K – 3000K 40K – 4000K 50K – 5000K BL – Blue RD – Red GN – Green AM – Amber RGB – RGB RGBA – RGBA RGBWW – RGBW(3000K) RGBNW – RGBW(4000K) tW – Tunable White	220V – 220V- 240V AC	L50 – 486mm	3 – 3° <hr/> 10 – 10° 15 – 15° 30 – 30° 45 – 45° 60 – 60°	– On/Off DMX – DMX/RDM

(1) 90 & 96LED is available for narrow beam 3° , 90LED for mono & RGB, 96LED for tW & RGBW

## Product Data

Product Family	Giant ECO G2 Triple Heads (BVP359 T)		
Dimensions (L x W x H)	486mm x 478mm x 231mm (with bracket)		
Source	High power LED		
Lumen Maintenance	50,000 hrsL70B50 at 35°C for White 50,000 hrsL50B50 at 35°C for RGB		
Housing	Extruded aluminum with die-cast aluminum end caps		
Finishing	Electrostatically applied polyester powder coating		
Color	Dark Grey (RAL7012)		
Bracket	Cold rolled sheet		
Adjustability	Tilting angle $\pm 45^\circ$		
Lenses	Anti-aging and anti-UV high optical efficiency PMMA lenses		
Gasket	Silicon		
Cover	Clear tempered glass		
Control Interfaces	On/Off	DMX12/RDM	
Input Voltage	220-240 VAC, 50/60Hz		
Total Harmonic Distortion	< 20%		
IEC Classification	Class I		
Power Cable (On/Off)	3 pole round cable L=50cm, 3x1.0mm <sup>2</sup> with flying wires		
Signal Cable (DMX)	4 pole round cable L=50cm, 4x0.50mm <sup>2</sup> (DMX versions only)		
Cables Connectors	IP67 Male/Female connectors for DMX through wiring (DMX versions only)		
Max Weight	18.8kg		
Standard Number of LEDs	90LED	96LED	<b>180LED</b>
Standard Optics	3°		10°, 15°, 30°, 45°, 60°
Max Power Consumption	240W		360W
Inrush Current <sup>(1)</sup>	<60A		
Maximum Number of Luminaires on 16A Type C MCB <sup>(1)</sup>	10		7
Standard CCT/Colors	2700K, 3000K, 4000K, RGB	RGBW	2700K, 3000K, 4000K, RGB, RGBW
Standard CRI	80		
White SDCM	4		
Colors Wavelength	R: 620 to 625nm; G: 525 to 530nm; B: 470 to 475nm		
Temperature Range	-40°C to 50°C (Operating) -35°C to 50°C (Startup) -40°C to 70°C (Storage)		
Protection Rating	IP66, IK06		
Certifications	CE, CB, CQC(in progressing)		
Warranty	3 Years		

(1) Inrush current and MCBs data are based on White, RGB and RGBW luminaires

**Luminaire Dimensions:**

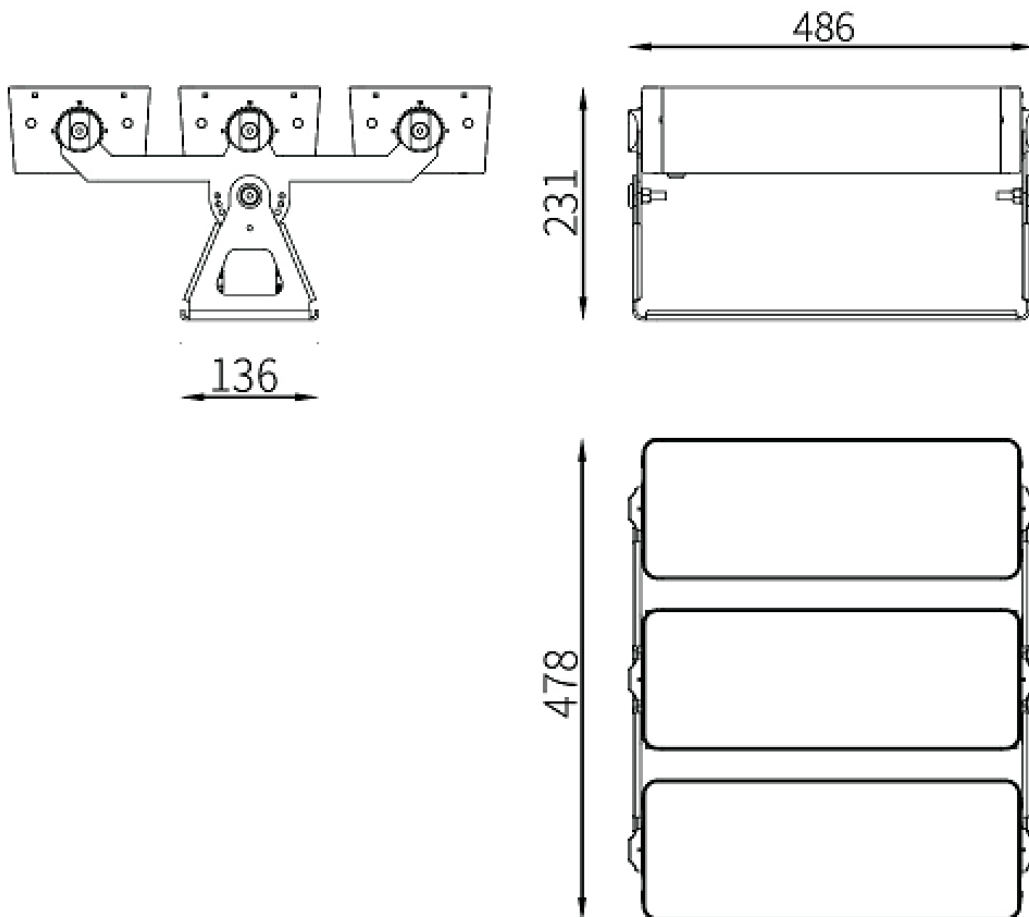

**Polar Candela Distribution Curves:**

**3x3° Beam Angle**

**Features:**

The 3x3° beam angle delivers a very narrow beam with more lumens where you want them.

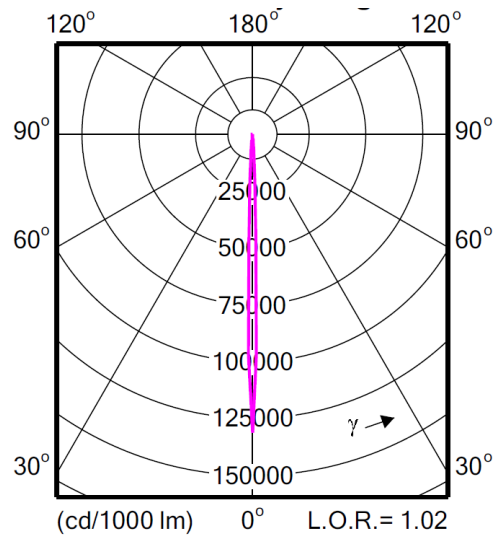

**10x10° Beam Angle**

**Features:**

The 10x10° beam angle offers a narrow beam that can be used to highlight a small area in a building or making an ornament stands out.

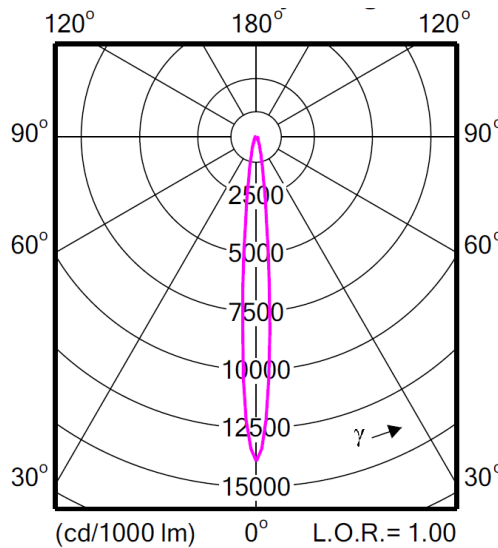

**15x15° Beam Angle**

**Features:**

The 15x15° beam angle offers a medium beam distribution that can be used to highlight a small to medium area in a building or making an ornament stands out.

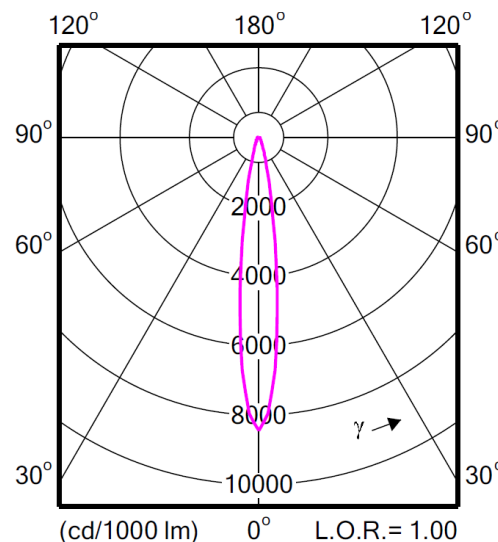

## Polar Candela Distribution Curves:

### 30x30° Beam Angle

**Features:**

The 30x30° beam angle offers a wide beam that can be used for highlighting medium to large areas in a building or used for general façade lighting.

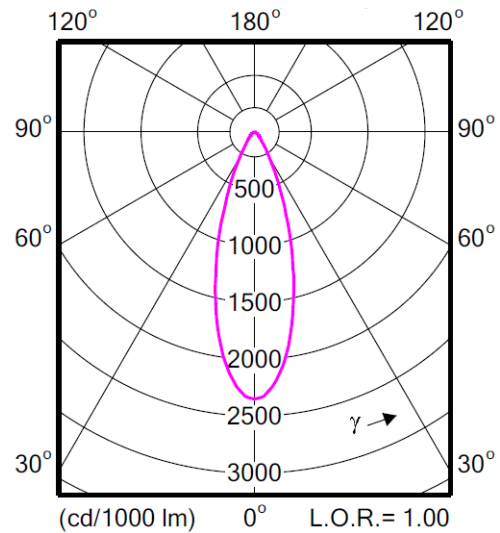

### 45x45° Beam Angle

**Features:**

The 45x45° beam angle offers a wide beam that can be used for highlighting large and wide areas in a building or used for general façade lighting.

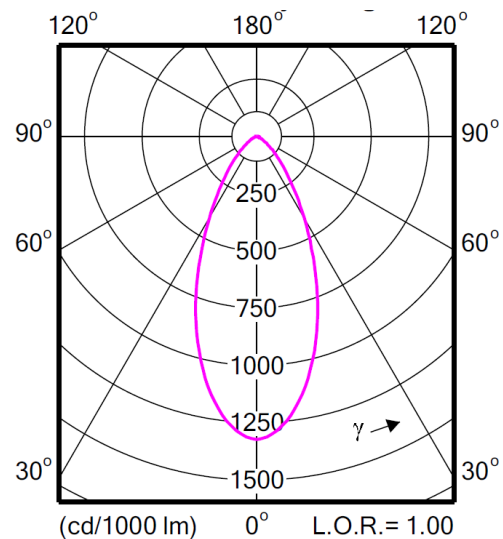

### 60x60° Beam Angle

**Features:**

The 60x60° beam angle offers a wide flood distribution that can be used to highlight larger and wider areas in a building or for general façade lighting.

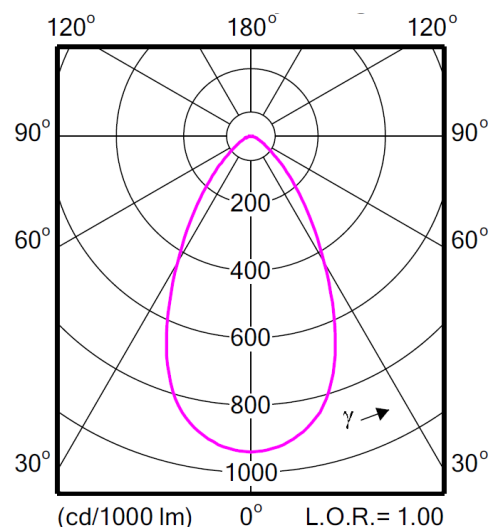

## Rated System Lumen Output ( $\pm 10\%$ ):

### BVP359 T L50 Version

CCT/Color (All channels On)	3° DMX	10° DMX	15° DMX	30° DMX	45° DMX	60° DMX
2700K	13530	26425	27745	28735	27745	27085
3000K	15225	27565	28940	29975	28940	28250
4000K	15225	30750	32290	33445	32290	31520
RGB	7010	15655	16440	17025	16440	16050
RGBWW	8850	17990	18890	19565	18890	18440
RGBNW	9270	18790	19730	20435	19730	19260

## Accessories

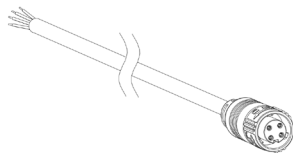

Leader cable 4P DMX  
2m

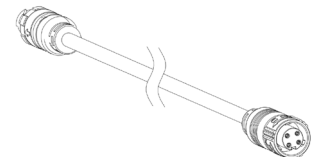

Jumper cable 4P DMX  
2m

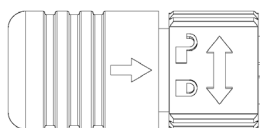

End cap for male  
connectors

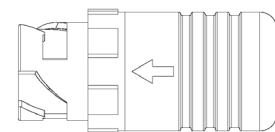

End cap for female  
connectors

