

Giant ECO G2 Single Head (BVP359 S)

Giant ECO G2 is a modular, rectangular shaped, cost effective and exterior-rated architectural LED floodlight that is designed for façade, landscape and outdoor flood lighting applications.

The robust mechanical design and high-efficient optical design make it ideal for illuminating multi-story exterior facades, bridges, landmarks and monuments.

Available in white, monochromatic colors, RGB, RGBW and tunable white.

Six different spread lenses ranging from narrow spot, to wide flood and DMX512/RDM control option available to give architects and designers the freedom to explore a wide range of concepts and design with no limitations.



Key Features (BVP359 S)

- Standard: RGBW, RGB, 2700K, 3000K and 4000K
- Optional 5000K, Monochromatic Colors and Tunable White
- Standard lengths 155, 183, 210, 238, 293, 348, 403, 486 and 569mm
- Wide Range of Beam Angles from Narrow Spot to Wide Flood
- 1 foot-candle at up to 254m (L57, 4000K, 3° lens)
- Robust Design & IP66 rating for outdoor use
- Adjustable $\pm 90^\circ$ tilting angle
- Available in DMX/RDM control interface option

Ordering guide

ex: *BVP359 S 36LED 40K 220V L35 10 DMX*

BVP359 S	36LED	40K	220V	L35	10	DMX
<u>Family</u>	<u># of LEDs</u>	<u>CCT / Color</u>	<u>Voltage</u>	<u>Length</u>	<u>Beam Angles</u>	<u>Control Interface</u>
BVP359 S – Giant ECO G2 Single Head	36LED	27K – 2700K 30K – 3000K 40K – 4000K 50K – 5000K BL – Blue RD – Red GN – Green AM – Amber RGB – RGB RGBA – RGBA RGBWW – RGBW(3000K) RGBNW – RGBW(4000K) tW – Tunable White	220V – 220V- 240V AC	L35 – 348mm	10 – 10° 15 – 15° 30 – 30° 45 – 45° 60 – 60°	– On/Off DMX – DMX/RDM

Product Data

Product Family	Giant ECO G2 Single Head (BVP359 S)	
Dimensions (L x W x H)	348mm x 140mm x 149mm (with bracket)	
Source	High power LED	
Lumen Maintenance	50,000 hrsL70B50 at 35°C for White 50,000 hrsL50B50 at 35°C for RGB	
Housing	Extruded aluminum with die-cast aluminum end caps	
Finishing	Electrostatically applied polyester powder coating	
Color	Dark Grey (RAL7012)	
Bracket	Cold rolled sheet	
Adjustability	Tilting angle $\pm 90^\circ$	
Lenses	Anti-aging and anti-UV high optical efficiency PMMA lenses	
Gasket	Silicon	
Cover	Clear tempered glass	
Control Interfaces	On/Off	DMX12/RDM
Input Voltage	220-240 VAC, 50/60Hz	
Total Harmonic Distortion	< 20%	
IEC Classification	Class I	
Power Cable (On/Off)	3 pole round cable L=50cm, 3x1.0mm ² with flying wires	
Signal Cable (DMX)	4 pole round cable L=50cm, 4x0.50mm ² (DMX versions only)	
Cables Connectors	IP67 Male/Female connectors for DMX through wiring (DMX versions only)	
Max Weight	4.8kg	
Standard Number of LEDs	36LED	
Standard Optics	10°, 15°, 30°, 45°, 60°	
Max Power Consumption	80W	
Inrush Current ⁽¹⁾	<60A	
Maximum Number of Luminaires on 16A Type C MCB ⁽¹⁾	39	
Standard CCT/Colors	2700K, 3000K, 4000K, RGB, RGBW	
Standard CRI	80	
White SDCM	4	
Colors Wavelength	R: 620 to 625nm; G: 525 to 530nm; B: 470 to 475nm	
Temperature Range	-40°C to 50°C (Operating) -35°C to 50°C (Startup) -40°C to 70°C (Storage)	
Protection Rating	IP66, IK06	
Certifications	CE, CB, CQC(in progressing)	
Warranty	3 Years	

(1) Inrush current and MCBs data are based on White, RGB and RGBW luminaires

Luminaire Dimensions:

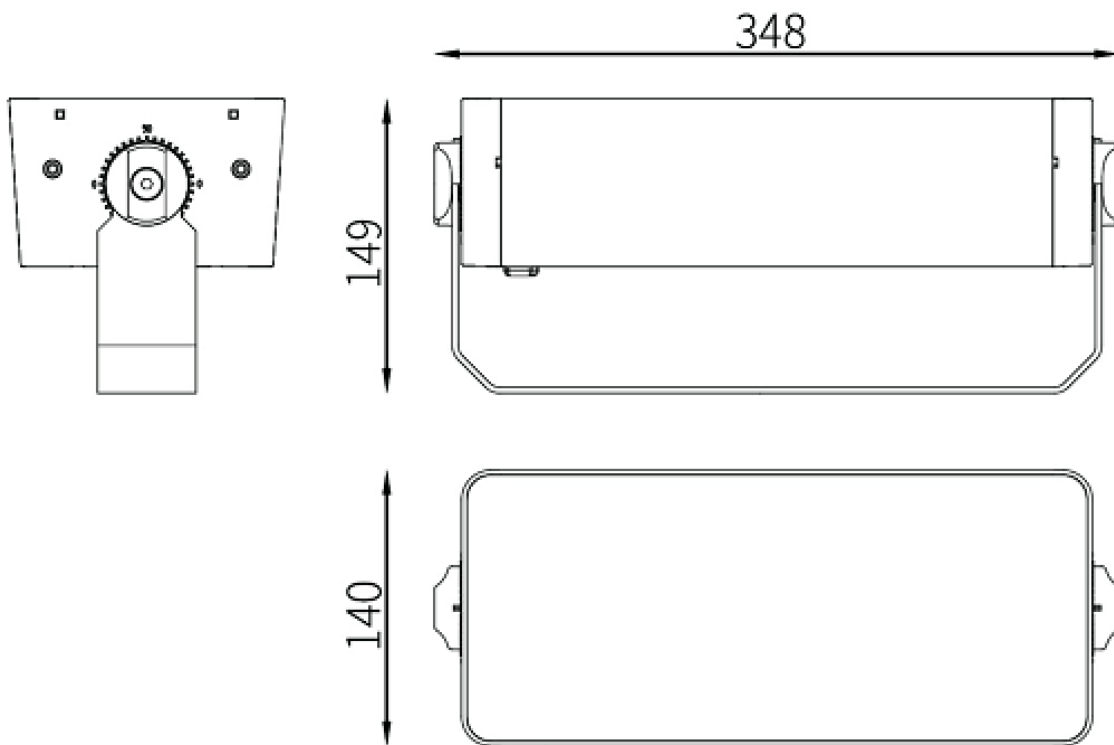

Polar Candela Distribution Curves:

3x3° Beam Angle

Features:

The 3x3° beam angle delivers a very narrow beam with more lumens where you want them.

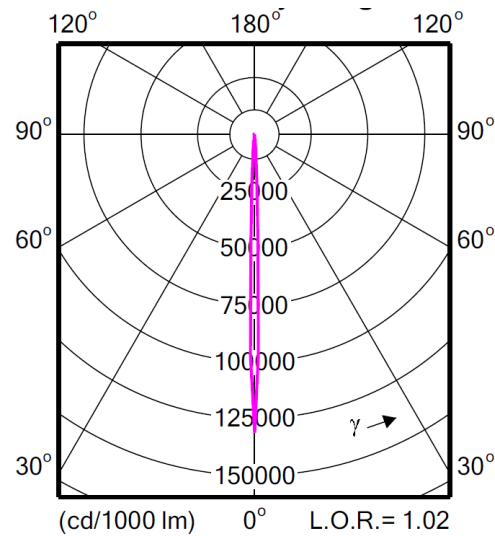

10x10° Beam Angle

Features:

The 10x10° beam angle offers a narrow beam that can be used to highlight a small area in a building or making an ornament stands out.

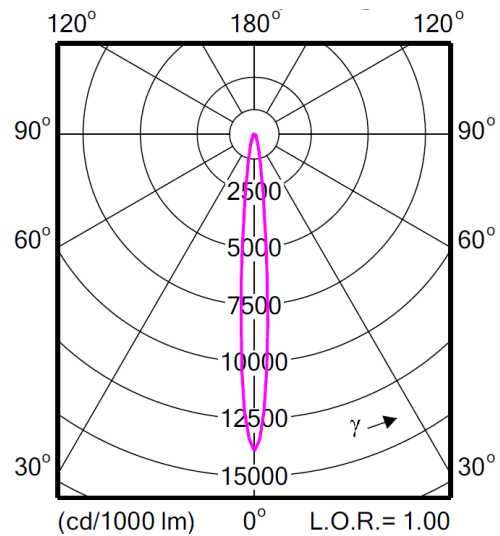

15x15° Beam Angle

Features:

The 15x15° beam angle offers a medium beam distribution that can be used to highlight a small to medium area in a building or making an ornament stands out.

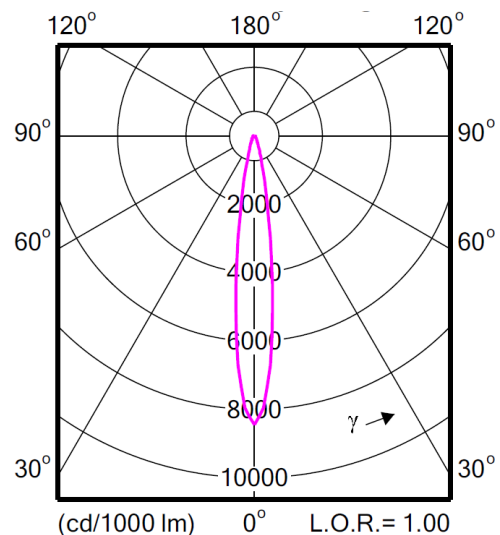

Polar Candela Distribution Curves:

30x30° Beam Angle

Features:

The 30x30° beam angle offers a wide beam that can be used for highlighting medium to large areas in a building or used for general façade lighting.

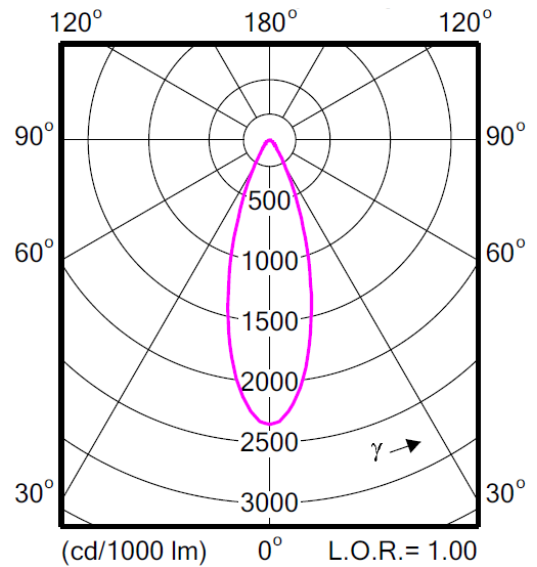

45x45° Beam Angle

Features:

The 45x45° beam angle offers a wide beam that can be used for highlighting large and wide areas in a building or used for general façade lighting.

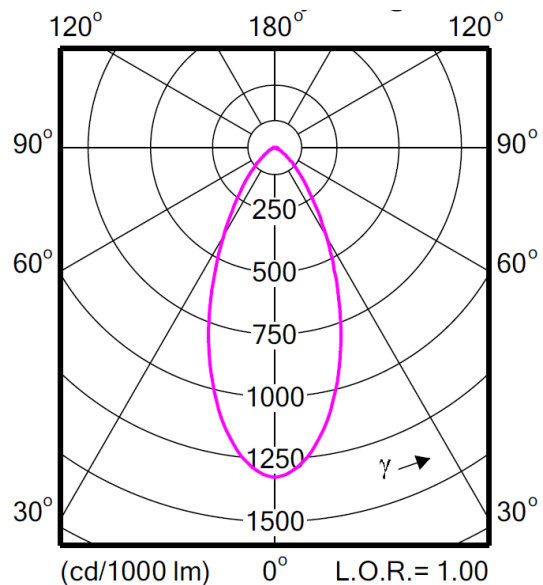

60x60° Beam Angle

Features:

The 60x60° beam angle offers a wide flood distribution that can be used to highlight larger and wider areas in a building or for general façade lighting.

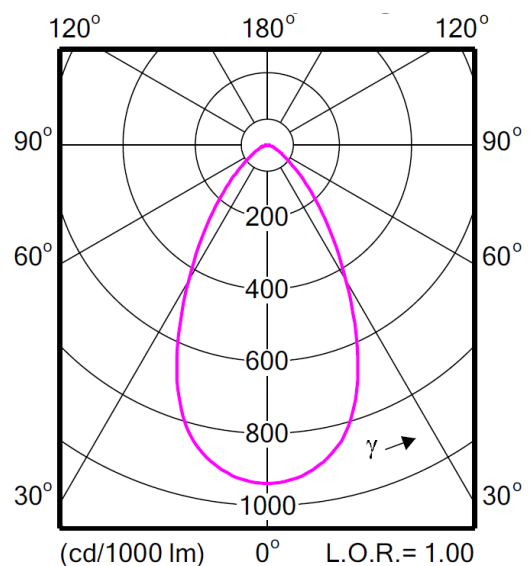

Rated System Lumen Output ($\pm 10\%$):

BVP359 S L35 Version

CCT/Color (All channels On)	3° DMX	10° DMX	15° DMX	30° DMX	45° DMX	60° DMX
2700K	-	5350	5620	5820	5620	5485
3000K	-	5585	5860	6070	5860	5725
4000K	-	6230	6540	6775	6540	6385
RGB	-	3290	3455	3580	3455	3370
RGBWW	-	3640	3825	3960	3825	3730
RGBNW	-	3805	3995	4135	3995	3900

Accessories

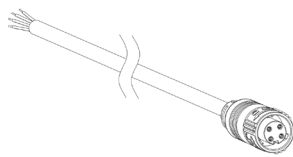

Leader cable 4P DMX
2m

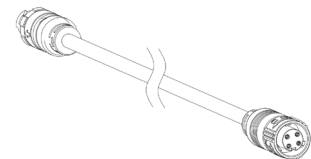

Jumper cable 4P DMX
2m

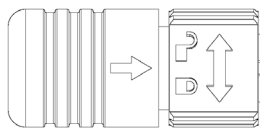

End cap for male
connectors

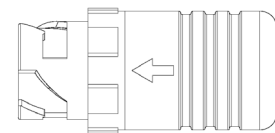

End cap for female
connectors

